

# Inductive sensor NI3-EG08-AP6X-V1131

**TURCK**  
*works*

Industrial  
Automation

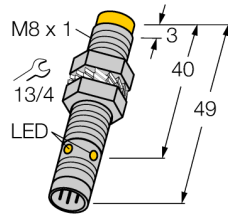

- Threaded barrel, M8 x 1
- Stainless steel, 1.4427 SO
- DC 3-wire, 10...30 VDC
- NO contact, PNP output
- M8 x 1 male connector

### Wiring Diagram

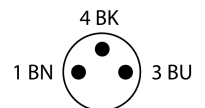
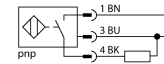

<b>Type designation</b>	NI3-EG08-AP6X-V1131
Ident-No.	4602750
<b>Rated switching distance Sn</b>	3 mm
Mounting conditions	Non-flush
Secured operating distance	$\leq (0,81 \times S_n)$ mm
Correction factors	St37 = 1; Al = 0.3; stainless steel = 0.7; Ms = 0.4
Repeat accuracy	$\leq 2\%$ of full scale
Temperature drift	$\leq \pm 10\%$
Hysteresis	3...15 %
Ambient temperature	-25...+70 °C
<b>Operating voltage</b>	10...30 VDC
Residual ripple	$\leq 10\% U_{ss}$
DC rated operational current	$\leq 150$ mA
No-load current $I_0$	$\leq 15$ mA
Residual current	$\leq 0.1$ mA
Isolation test voltage	$\leq 0.5$ kV
Short-circuit protection	yes/ Cyclic
Voltage drop at $I_0$	$\leq 1.8$ V
Wire breakage/Reverse polarity protection	yes/ Complete
Output function	3-wire, NO contact, PNP
Switching frequency	3 kHz
<b>Design</b>	Threaded barrel, M8 x 1
Dimensions	49 mm
Housing material	Stainless steel, 1.4427 SO
Active area material	Plastic, PA12-GF30
Max. tightening torque housing nut	5 Nm
Electrical connection	Connector, M8 x 1
Vibration resistance	55 Hz (1 mm)
Shock resistance	30 g (11 ms)
Protection class	IP67
MTTF	2283 years acc. to SN 29500 (Ed. 99) 40 °C
<b>Switching state</b>	LED, Yellow

### Functional principle

Inductive sensors detect metal objects contactless and wear-free. For this, they use a high-frequency electromagnetic AC field that interacts with the target. Inductive sensors generate this field via an RLC circuit with a ferrite coil.

# Inductive sensor NI3-EG08-AP6X-V1131

**TURCK**  
*works*

Industrial  
Automation

---

Distance D	3 x B
Distance W	3 x Sn
Distance T	3 x B
Distance S	1.5 x B
Distance G	6 x Sn
Distance N	2 x Sn

---

Diameter active area B                     $\varnothing$  8 mm

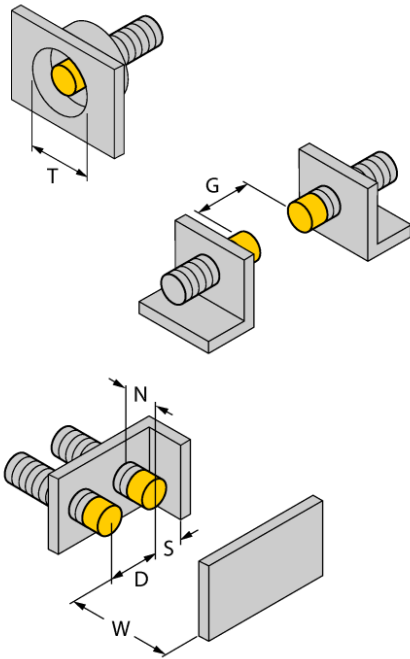

**Inductive sensor  
NI3-EG08-AP6X-V1131**

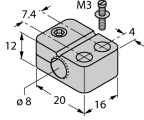
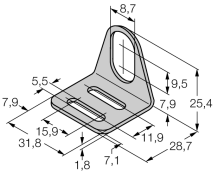
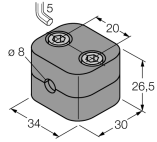
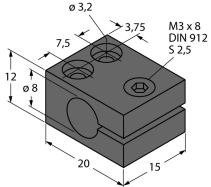

**Accessories**

Type code	Ident-No.	Description	
BST-08B	6947210	Fixing clamp for threaded barrel devices, with dead-stop; material: PA6	
MW-08	6945008	Mounting bracket for threaded barrel devices; material: Stainless steel A2 1.4301 (AISI 304)	
BSS-08	6901322	Mounting bracket for smooth and threaded barrel devices; material: Polypropylene	
MBS80	69479	Mounting bracket for threaded barrel devices; material mounting block: Anodized aluminium	

**Wiring accessories**

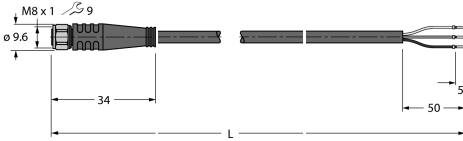
Type code	Ident-No.	Description	
PKG3M-2/TEL	6625385	Connection cable, female M8, straight, 3-pin, stainless steel coupling nut, cable length: 2 m, sheath material: PVC, black; cULus approval; other cable lengths and qualities available, see <a href="http://www.turck.com">www.turck.com</a>	

Edition • 2018-04-24T15:35:02+02:00