

## eurofast® Cordsets & Extensions, Large Plug Body, Rubber

- Rubber Cable
- Available in 3 and 4 Conductor
- 18 AWG Conductors
- Anti-vibration Coupling Nut

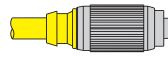

See table below



RKG ..

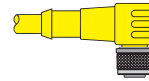

WKE ..

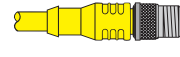

RSE ..

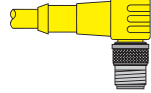

WSE ..

### 4-Pin, Large Plug Body, 250 V, 4.0 A

Application	Cable Specs	Pinout	Female		Male	
			Straight	Right Angle	Straight	Right Angle
Heavy duty for 3-wire DC Rubber cable UL Recognized CSA Certified	3/18 AWG Yellow CPE, SJOOW 105°C 8.0 mm OD	1. Bn 2. N/C 3. Bu 4. Bk	RKG 4T-*/S600	WKE 4T-*/S600	RSE 4T-*/S600	WSE 4T-*/S600
Heavy duty for 4-wire DC Rubber cable UL Recognized CSA Certified	4/18 AWG Yellow CPE, SJOOW 105°C 8.5 mm OD	1. Bn 2. Wh 3. Bu 4. Bk	RKG 4.4T-*/S600	WKE 4.4T-*/S600	RSE 4.4T-*/S600	WSE 4.4T-*/S600



RKG .. RSE ..

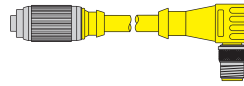

RKG .. WSE ..

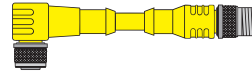

WKE .. RSE ..

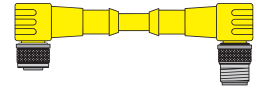

WKE .. WSE ..

### 4-Pin, Large Plug Body Extensions, 250 V, 4.0 A

Application	Cable Specs	Straight Female		Right Angle Female	
		Straight Male	Right Angle Male	Straight Male	Right Angle Male
Heavy duty for 4-wire DC Rubber cable UL Recognized CSA Certified	See tables above	RKG 4.4T-*/RSE 4.4T/S600	RKG 4.4T-*/WSE 4.4T/S600	WKE 4.4T-*/RSE 4.4T/S600	WKE 4.4T-*/WSE 4.4T/S600

\* = Length in meters

## Specifications

<b>Connector:</b>	Oil resistant polyurethane body material, PUR contact carrier, spacings to VDE 0110 Group C.
<b>Contacts:</b>	Gold plated brass.
<b>Coupling Nuts:</b>	Nickel plated brass.
<b>Cable:</b>	See table.
<b>Protection:</b>	NEMA 1,3,4,6P and IEC IP 68.
<b>Cable Length:</b>	Standard cable lengths are nominal 2, 4 and 6 meters. Other lengths available by request - consult factory.

## Dimensions

**RKG .. - \* -RSE ..**

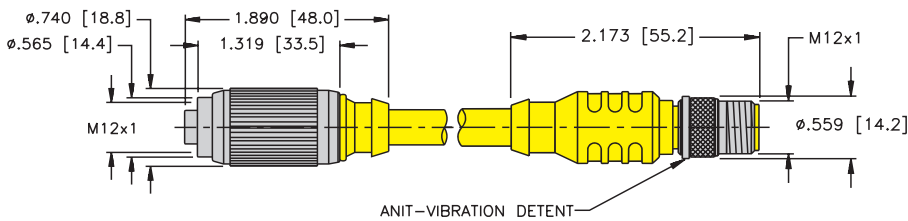

**Note:**

Replace right end of illustrations at left with WSE shown below for RKG ..\*-WSE .. and WKE ..\*-WSE .. Configuration. Dimensions for single ended styles remain the same.

**WKE .. - \* -RSE ..**

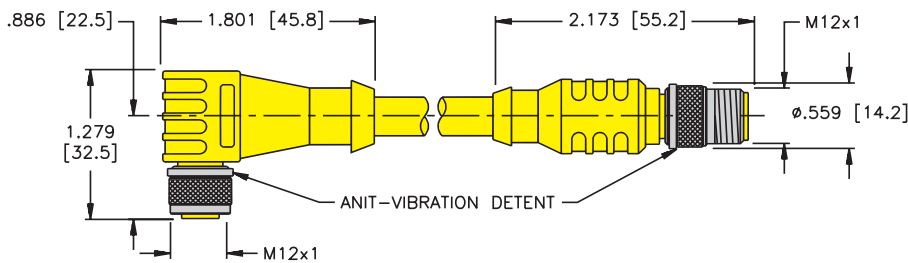

**.. -WSE ..**

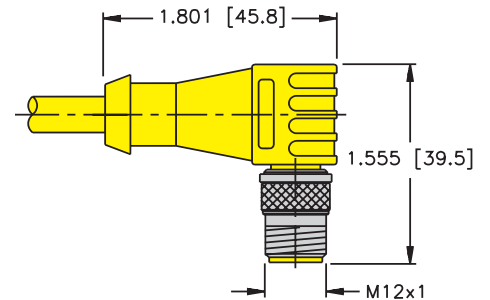

## Pinouts

Female	Male
<b>4-pin</b>	<b>4-pin</b>